



# **Betriebsanleitung Operating Instructions**

**Platten- und Verbundsteintrenner  
Plate - Compositestone Cutter**

**AL**



Bitte beachten Sie, dass das Produkt ohne vorliegende Betriebsanleitung in Landessprache nicht eingesetzt / in Betrieb gesetzt werden darf. Sollten Sie mit der Lieferung des Produkts keine Betriebsanleitung in Ihrer Landessprache erhalten haben, kontaktieren Sie uns bitte. In Länder der EU / EFTA senden wir Ihnen diese kostenlos nach. Für Länder außerhalb der EU / EFTA erstellen wir Ihnen gerne ein Angebot für eine Betriebsanleitung in Landessprache, falls die Übersetzung nicht durch den Händler/Importeur organisiert werden kann.

Please note that the product may not be used / put into operation without these operating instructions in the national language. If you did not receive operating instructions in your national language with the delivery of the product, please contact us. In countries of the EU / EFTA we will send them to you free of charge. For countries outside the EU / EFTA, we will be pleased to provide you with an offer for an operating manual in the national language if the translation cannot be organised by the dealer/importer.







# Betriebsanleitung

Original Betriebsanleitung

**Platten- und Verbundsteintrenner**

**AL**

## Inhalt

<b>1</b>	<b>Allgemeines .....</b>	<b>3</b>
<b>2</b>	<b>Sicherheit.....</b>	<b>3</b>
2.1	Sicherheitshinweise.....	3
2.2	Sicherheitskennzeichnung .....	4
2.3	Unfallschutz .....	4
2.4	Funktions- und Sichtprüfung.....	5
2.5	Definition Fachpersonal / Sachkundiger .....	5
2.6	Bestimmungsgemäßer Einsatz .....	5
2.7	Technische Daten .....	5
<b>3</b>	<b>Messertypen.....</b>	<b>6</b>
<b>4</b>	<b>Modelle .....</b>	<b>7</b>
<b>5</b>	<b>Modelle Übersicht.....</b>	<b>15</b>
5.1	Bedienung .....	16
5.1.1	Steine mittig Spalten .....	16
5.1.2	Gerätebedienung .....	16
<b>6</b>	<b>Wartung und Pflege.....</b>	<b>17</b>
6.1	Wartung .....	17
6.2	Reparaturen.....	17
6.3	Prüfungspflicht .....	17
6.4	Hinweis zum Typenschild .....	18
6.5	Hinweis zur Vermietung/Verleihung von PROBST-Geräten.....	18

## 1 Allgemeines



- Das Gerät darf nur für den in der Bedienungsanleitung beschriebenen bestimmungsgemäßen Einsatz, unter Einhaltung der gültigen Sicherheitsvorschriften und unter Einhaltung der dementsprechenden gesetzlichen Bestimmungen und den der Konformitätserklärung verwendet werden.
- Jeder anderweitige Einsatz gilt als nicht bestimmungsgemäß und ist **verboten!**
- Die am Einsatzort gültigen gesetzlichen Sicherheits- und Unfallvorschriften müssen zusätzlich eingehalten werden.



Der Anwender **muss** sich vor jedem Einsatz vergewissern, dass:

- das Gerät für den vorgesehenen Einsatz geeignet ist
- sich im ordnungsgemäßen Zustand befindet
- das Schneidgut für das Schneiden geeignet sind

In Zweifelsfällen setzen Sie sich vor der Inbetriebnahme mit dem Hersteller in Verbindung.

## 2 Sicherheit

### 2.1 Sicherheitshinweise



#### **Lebensgefahr!**

Bezeichnet eine Gefahr. Wenn sie nicht gemieden wird, sind Tod und schwerste Verletzungen die Folge.



#### **Gefährliche Situation!**

Bezeichnet eine gefährliche Situation. Wenn sie nicht gemieden wird, können Verletzungen oder Sachschäden die Folge sein.



#### **Verbot!**

Bezeichnet ein Verbot. Wenn es nicht eingehalten wird, sind Tod und schwerste Verletzungen, oder Sachschäden die Folge.



Wichtige Informationen oder nützliche Tipps zum Gebrauch.

## 2.2 Sicherheitskennzeichnung

### VERBOTSZEICHEN

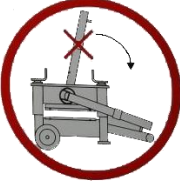
Symbol	Bedeutung	Bestell-Nr.:	Größe:
	Das Gerät nicht mit stehendem Bügel lagern. Es besteht die Gefahr das der Bügel sich löst. Verletzungsgefahr.	---	---

### WARNZEICHEN

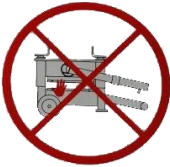
Symbol	Bedeutung	Bestell-Nr.:	Größe:
	Quetschgefahr der Hände.	---	---

### GEBOTSZEICHEN

Symbol	Bedeutung	Bestell-Nr.:	Größe:
	Gehör- und Augenschutz tragen.	29040547	50 mm

## 2.3 Unfallschutz



- Arbeitsbereich für unbefugte Personen, insbesondere Kinder, weiträumig absichern.
- Vorsicht bei Gewitter!



- Arbeitsbereich ausreichend beleuchten.
- Vorsicht bei nassen, angefrorenen oder verschmutzten Baustoffen.



- Das Arbeiten mit dem Gerät bei Witterungsverhältnissen unter 3 °C (37,5 °F) ist verboten! Es besteht die Gefahr des Abrutschens der Greifgüter bedingt durch Nässe oder Vereisung.



## 2.4 Funktions- und Sichtprüfung



- Das Gerät muss vor jedem Arbeitseinsatz auf Funktion und Zustand geprüft werden.
- Wartung, Schmierung und Störungsbeseitigung dürfen nur bei stillgelegtem Gerät erfolgen!



- Bei Mängeln, die die Sicherheit betreffen, darf das Gerät erst nach einer kompletten Mängelbeseitigung wieder eingesetzt werden.
- Bei jeglichen Rissen, Spalten oder beschädigten Teilen an irgendwelchen Teilen des Gerätes, muss **sofort** jegliche Nutzung des Gerätes gestoppt werden.



- Die Betriebsanleitung für das Gerät muss am Einsatzort jederzeit einsehbar sein.
- Das am Gerät angebrachte Typenschild darf nicht entfernt werden.
- Unlesbare Hinweisschilder (wie Verbots- und Warnzeichen) sind auszutauschen.

## 2.5 Definition Fachpersonal / Sachkundiger

Installations-, Wartungs- und Reparaturarbeiten an diesem Gerät dürfen nur von Fachpersonal oder Sachkundigen durchgeführt werden!

Fachpersonal oder Sachkundige müssen für die folgenden Bereiche, soweit es für dieses Gerät zutrifft, die notwendigen beruflichen Kenntnisse besitzen:

- für Mechanik
- für Hydraulik
- für Pneumatik
- für Elektrik

## 2.6 Bestimmungsgemäßer Einsatz



**ACHTUNG:** Das Arbeiten mit diesem Gerät darf nur in bodennahem Bereich erfolgen (→ Kapitel „Sicherheit im Betrieb“)!



**Eigenmächtige Umbauten** am Gerät oder der Einsatz von eventuell selbstgebaute Zusatzvorrichtungen gefährden Leib und Leben und sind deshalb grundsätzlich **verboten!**



- Das Gerät darf nur für den in der Bedienungsanleitung beschriebenen bestimmungsgemäßen Einsatz unter Einhaltung der gültigen Sicherheitsvorschriften und unter Einhaltung der dementsprechenden gesetzlichen Bestimmungen verwendet werden.
- Jeder anderweitige Einsatz gilt als nicht bestimmungsgemäß und ist **verboten!**
- Die am Einsatzort gültigen gesetzlichen Sicherheits- und Unfallvorschriften müssen zusätzlich eingehalten werden.



Der Anwender muss sich vor jedem Einsatz vergewissern, dass:

- das Gerät für den vorgesehenen Einsatz geeignet ist, sich im ordnungsgemäßen Zustand befindet und die zu hebenden Lasten für das Heben geeignet sind.

*In Zweifelsfällen setzen Sie sich vor der Inbetriebnahme mit dem Hersteller in Verbindung.*

## 2.7 Technische Daten

Die genauen technischen Daten (wie z.B. Tragfähigkeit, Eigengewicht, etc.) sind dem Typenschild / Datenblatt zu entnehmen.

### 3 Messertypen

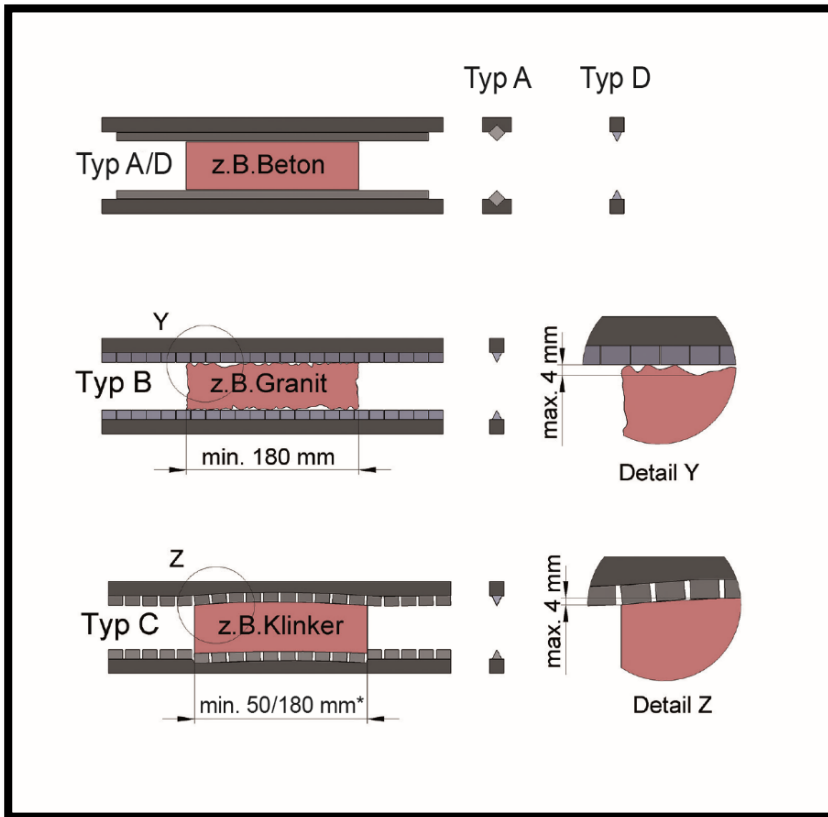

#### Verschiedenartige Steintrenner mit optimalen Schneidmessern für jede Aufgabe.

- **Typ A+D:** Starres, durchgängiges Drei /Vierkant-Wendemesser aus gehärtetem Werkzeugstahl. Für alltägliche Aufgabenstellungen, insbesondere für Betonpflastersteine.
  - Messer Typ A: 4 Schneidkanten.
  - Messer Typ D: 3 Schneidkanten.
- **Typ B:** Starr gelagertes, geteiltes Dreikant- Wendemesser aus Hartmetall. Z.B. für Granitsteine, max. 4 mm Höhenunterschied, minimale Steinlänge
  - Messer hat 3 Schneidkanten
- **Typ C:** Flexibel gelagertes, geteiltes Dreikant- Wendemesser aus Hartmetall. Für leicht konkave oder konvexe Steinelemente, wie z.B. Klinker und große Steinplatte mit max. 4 mm Höhenunterschied.
  - \*minimale Steinlänge 50 mm oder 180 mm, je nach Modell.
  - Messer hat 3 Schneidkanten

4 Modelle

**AL-15-EASY-V**

Typ Messer	Steingröße	Anwendung	Gewicht	Bestellnummer
 Messer Typ A	Breite: 175mm	Werkstoff: Beton	14 Kg	51200066
	Höhe: 50-100mm	<ul style="list-style-type: none"> <li>• Klinker</li> <li>• Kleiner Klinker</li> </ul>		

1) Einstellung auf die gewünschte Steinhöhe erfolgt bequem und schnell mit einer Hand über leichtgängige Rändelschraube (Messer sollte Werkstück nur minimal berühren)  
 2) Die Rändelschraube um eine halbe Drehung zurückdrehen, dass minimaler Spalt zwischen Messer und Werkstück entsteht  
 3) Durch herunterdrücken des Hebels wird der Stein / die Platte durchtrennt

**AL-33-EASY-V**

Typ Messer	Steingröße	Anwendung	Gewicht	Bestellnummer
 Messer Typ A	Breite: 330mm	Werkstoff: Beton	42 Kg	51200059  Messer: 41200001
	Höhe: 10-120mm	<ul style="list-style-type: none"> <li>• Pflastersteine</li> <li>• Platten</li> </ul>		

1) Einstellung auf die gewünschte Steinhöhe erfolgt bequem und schnell mit einer Hand über leichtgängige Handkurbel (Messer sollte Werkstück nur minimal berühren)  
 2) Die Handkurbel um eine halbe Drehung zurückdrehen, dass minimaler Spalt zwischen Messer und Werkstück entsteht  
 3) Durch herunterdrücken des Hebels wird der Stein / die Platte durchtrennt

AL-33/D-EASY-V				
Typ Messer	Steingröße	Anwendung	Gewicht	Bestellnummer
<p>Messer Typ A</p>	Breite: 330mm  Höhe: 10-120mm	Werkstoff: Beton  • Pflastersteine • Platten	42 Kg	51200060  Messer: 41200001
1) Einstellung auf die gewünschte Steinhöhe erfolgt bequem und schnell mit einer Hand über leichtgängige Handkurbel (Messer sollte Werkstück nur minimal berühren) 2) Die Handkurbel um eine halbe Drehung zurückdrehen, dass minimaler Spalt zwischen Messer und Werkstück entsteht 3) Durch herunterdrücken des Hebels wird der Stein / die Platte durchtrennt				

AL-33-V				
Typ Messer	Steingröße	Anwendung	Gewicht	Bestellnummer
<p>Messer Typ A</p>	Breite: 330mm  Höhe: 10-120mm	Werkstoff: Beton  • Pflastersteine • Platten	41 Kg	51200042  Messer: 41200001
1) Einstellung auf die gewünschte Steinhöhe erfolgt bequem und schnell mit einer Hand über leichtgängige Handkurbeln (Messer sollte Werkstück nur minimal berühren) 2) Die Handkurbeln um eine halbe Drehung zurückdrehen, dass minimaler Spalt zwischen Messer und Werkstück entsteht (beide Kurbeln gleichzeitig auf-/ ab-drehen, um ein Verkanten zu vermeiden) 3) Durch herunterdrücken des Hebels wird der Stein / die Platte durchtrennt				

AL-33/D-V				
Typ Messer	Steingröße	Anwendung	Gewicht	Bestellnummer
<p>Messer Typ A</p>	<p>Breite: 330mm</p> <p>Höhe: 10-120mm</p>	<p>Werkstoff: Beton</p> <ul style="list-style-type: none"> <li>• Pflastersteine</li> <li>• Platten</li> </ul>	41 Kg	<p>51200049</p> <p>Messer: 41200001</p>
<p>1) Einstellung auf die gewünschte Steinhöhe erfolgt bequem und schnell mit einer Hand über leichtgängige Handkurbeln (Messer sollte Werkstück nur minimal berühren)</p> <p>2) Die Handkurbeln um eine halbe Drehung zurückdrehen, dass minimaler Spalt zwischen Messer und Werkstück entsteht (beide Kurbeln gleichzeitig auf-/ ab-drehen, um ein Verkanten zu vermeiden)</p> <p>3) Durch herunterdrücken des Hebels wird der Stein / die Platte durchtrennt</p>				

AL-33/S-V				
Typ Messer	Steingröße	Anwendung	Gewicht	Bestellnummer
<p>Messer Typ C</p>	<p>Breite: 50-340mm</p> <p>Höhe: 20-140mm</p>	<p>Werkstoff: Beton</p> <ul style="list-style-type: none"> <li>• Pflastersteine</li> <li>• Hartgebackene Klinker</li> <li>• Platten</li> </ul>	53 Kg	<p>51200044</p> <p>Messer: 21100054</p>
<p>1) Einstellung auf die gewünschte Steinhöhe erfolgt bequem und schnell mit einer Hand über leichtgängige Handkurbeln (Messer sollte Werkstück nur minimal berühren)</p> <p>2) Die Handkurbeln um eine halbe Drehung zurückdrehen, dass minimaler Spalt zwischen Messer und Werkstück entsteht (beide Kurbeln gleichzeitig auf-/ ab-drehen, um ein Verkanten zu vermeiden)</p> <p>3) Durch herunterdrücken des Hebels wird der Stein / die Platte durchtrennt</p>				

**AL-43-EASY-V**

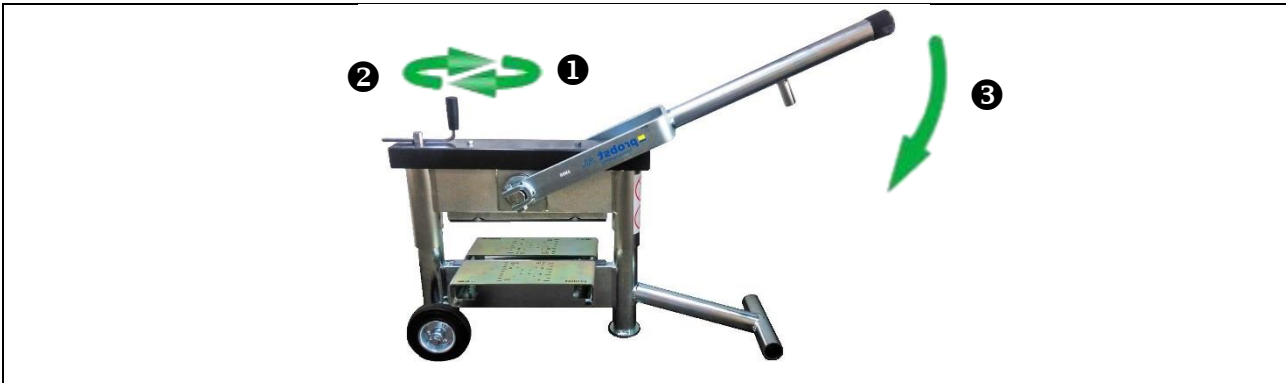

Typ Messer	Steingröße	Anwendung	Gewicht	Bestellnummer
 Messer Typ A	Breite: 430mm	Werkstoff: Beton	60 Kg	51200061
	Höhe: 10-120mm	<ul style="list-style-type: none"> <li>• Pflastersteine</li> <li>• Platten</li> </ul>		Messer: 41200002

- 1) Einstellung auf die gewünschte Steinhöhe erfolgt bequem und schnell mit einer Hand über leichtgängige Handkurbel (Messer sollte Werkstück nur minimal berühren)
- 2) Die Handkurbel um eine halbe Drehung zurückdrehen, dass minimaler Spalt zwischen Messer und Werkstück entsteht
- 3) Durch herunterdrücken des Hebels wird der Stein / die Platte durchtrennt

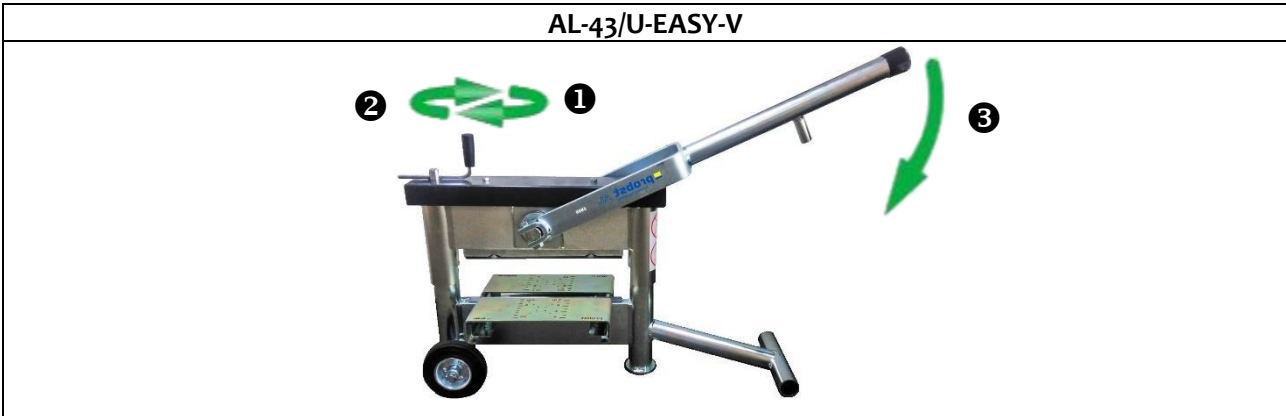

Typ Messer	Steingröße	Anwendung	Gewicht	Bestellnummer
 Messer Typ A	Breite: 430mm	Werkstoff: Beton	73 Kg	51200064
	Höhe: 10-120mm	<ul style="list-style-type: none"> <li>• Pflastersteine</li> <li>• Platten</li> </ul>		Messer: 41200002

- 1) Einstellung auf die gewünschte Steinhöhe erfolgt bequem und schnell mit einer Hand über leichtgängige Handkurbel (Messer sollte Werkstück nur minimal berühren)
- 2) Die Handkurbel um eine halbe Drehung zurückdrehen, dass minimaler Spalt zwischen Messer und Werkstück entsteht
- 3) Durch herunterdrücken des Hebels wird der Stein / die Platte durchtrennt

AL-43/UT-EASY-V				
Typ Messer	Steingröße	Anwendung	Gewicht	Bestellnummer
<p>Messer Typ A</p>	Breite: 430mm	Werkstoff: Beton	81 Kg	51200068 Messer: 41200002
	Höhe: 10-400mm	<ul style="list-style-type: none"> <li>• Pflastersteine</li> <li>• Platten</li> <li>• Kalksandsteine</li> </ul>		
<p>1) Einstellung auf die gewünschte Steinhöhe erfolgt bequem und schnell mit einer Hand über leichtgängige Handkurbel (Messer sollte Werkstück nur minimal berühren)</p> <p>2) Die Handkurbel um eine halbe Drehung zurückdrehen, dass minimaler Spalt zwischen Messer und Werkstück entsteht</p> <p>3) Durch herunterdrücken des Hebels wird der Stein / die Platte durchtrennt</p>				

AL-43-V				
Typ Messer	Steingröße	Anwendung	Gewicht	Bestellnummer
<p>Messer Typ A</p>	Breite: 430mm	Werkstoff: Beton	57 Kg	51200043 Messer: 41200002
	Höhe: 10-120mm	<ul style="list-style-type: none"> <li>• Pflastersteine</li> <li>• Platten</li> </ul>		
<p>1) Einstellung auf die gewünschte Steinhöhe erfolgt bequem und schnell mit einer Hand über leichtgängige Handkurbeln (Messer sollte Werkstück nur minimal berühren)</p> <p>2) Die Handkurbeln um eine halbe Drehung zurückdrehen, dass minimaler Spalt zwischen Messer und Werkstück entsteht (beide Kurbeln gleichzeitig auf-/ ab-drehen, um ein Verkanten zu vermeiden)</p> <p>3) Durch herunterdrücken des Hebels wird der Stein / die Platte durchtrennt</p>				

AL-43/S-V				
Typ Messer	Steingröße	Anwendung	Gewicht	Bestellnummer
<p>Messer Typ C</p>	<p>Breite: 180-430mm</p> <p>Höhe: 20-140mm</p>	<p>Werkstoff: Beton</p> <ul style="list-style-type: none"> <li>• Pflastersteine</li> <li>• Platten</li> <li>• Hartgebackene Klinker</li> </ul>	63 Kg	<p>51200045</p> <p>Messer: 21100057</p>
<p>1) Einstellung auf die gewünschte Steinhöhe erfolgt bequem und schnell mit einer Hand über leichtgängige Handkurbeln (Messer sollte Werkstück nur minimal berühren)</p> <p>2) Die Handkurbeln um eine halbe Drehung zurückdrehen, dass minimaler Spalt zwischen Messer und Werkstück entsteht (beide Kurbeln gleichzeitig auf-/ ab-drehen, um ein Verkanten zu vermeiden)</p> <p>3) Durch herunterdrücken des Hebels wird der Stein / die Platte durchtrennt</p>				

AL-50/KS-V				
Typ Messer	Steingröße	Anwendung	Gewicht	Bestellnummer
<p>Messer Typ A</p>	<p>Breite: 500mm</p> <p>Höhe: 50-120mm</p>	<p>Werkstoff : Sandstein</p> <ul style="list-style-type: none"> <li>• Kalksandstein</li> </ul>	23 Kg	<p>55300005</p> <p>Messer: 41200027</p>
<p>1) Einstellung auf die gewünschte Steinhöhe erfolgt bequem und schnell mit einer Hand über leichtgängige Rändelmutter (Messer sollte Werkstück nur minimal berühren)</p> <p>2) Die Rändelmutter um eine halbe Drehung zurückdrehen, dass minimaler Spalt zwischen Messer und Werkstück entsteht</p> <p>3) Durch herunterdrücken des Hebels wird der Stein / die Platte durchtrennt</p>				



AL-65-V				
Typ Messer	Steingröße	Anwendung	Gewicht	Bestellnummer
<p>Messer Typ A</p>	Breite: 650mm  Höhe: 10-120mm	Werkstoff: Beton  • Pflastersteine • Platten	88 Kg	51200047  Messer: 41200001
1) Einstellung auf die gewünschte Steinhöhe erfolgt bequem und schnell mit einer Hand über leichtgängige Handkurbeln (Messer sollte Werkstück nur minimal berühren) 2) Die Handkurbeln um eine halbe Drehung zurückdrehen, dass minimaler Spalt zwischen Messer und Werkstück entsteht (beide Kurbeln gleichzeitig auf-/ ab-drehen, um ein Verkanten zu vermeiden) 3) Durch herunterdrücken des Hebels wird der Stein / die Platte durchtrennt				

AL-65-EASY-V				
Typ Messer	Steingröße	Anwendung	Gewicht	Bestellnummer
<p>Messer Typ A</p>	Breite: 650mm  Höhe: 10-120mm	Werkstoff: Beton  • Pflastersteine • Platten	92 Kg	51200067  Messer: 41200001
1) Einstellung auf die gewünschte Steinhöhe erfolgt bequem und schnell mit einer Hand über leichtgängige Handkurbel (Messer sollte Werkstück nur minimal berühren) 2) Die Handkurbel um eine halbe Drehung zurückdrehen, dass minimaler Spalt zwischen Messer und Werkstück entsteht 3) Durch herunterdrücken des Hebels wird der Stein / die Platte durchtrennt				

AL-65/U-EASY-V				
Typ Messer	Steingröße	Anwendung	Gewicht	Bestellnummer
<p>Messer Typ A</p>	Breite: 650mm  Höhe: 10-400mm	Werkstoff: Beton <ul style="list-style-type: none"> <li>• Pflastersteine</li> <li>• Platten</li> <li>• Bordsteine</li> </ul>	104 Kg	51200069  Messer: 41200001
1) Einstellung auf die gewünschte Steinhöhe erfolgt bequem und schnell mit einer Hand über leichtgängige Handkurbel (Messer sollte Werkstück nur minimal berühren) 2) Die Handkurbel um eine halbe Drehung zurückdrehen, dass minimaler Spalt zwischen Messer und Werkstück entsteht 3) Durch herunterdrücken des Hebels wird der Stein / die Platte durchtrennt				

AL-65/UT-EASY-V				
Typ Messer	Steingröße	Anwendung	Gewicht	Bestellnummer
<p>Messer Typ A</p>	Breite: 650mm  Höhe: 10-400mm	Werkstoff: Beton <ul style="list-style-type: none"> <li>• Pflastersteine</li> <li>• Platten</li> <li>• Kalksandsteine</li> <li>• Bordsteine</li> </ul>	115 Kg	51200070  Messer: 41200001
1) Einstellung auf die gewünschte Steinhöhe erfolgt bequem und schnell mit einer Hand über leichtgängige Handkurbel (Messer sollte Werkstück nur minimal berühren) 2) Die Handkurbel um eine halbe Drehung zurückdrehen, dass minimaler Spalt zwischen Messer und Werkstück entsteht 3) Durch herunterdrücken des Hebels wird der Stein / die Platte durchtrennt				

**AL-65/KS-EASY-V**

Typ Messer	Steingröße	Anwendung	Gewicht	Bestellnummer
 Messer Typ A	Breite: 650mm	Werkstoff: Beton <ul style="list-style-type: none"> <li>• Pflastersteine</li> <li>• Platten</li> <li>• Kalksandsteine</li> <li>• Bordsteine</li> </ul>	105 Kg	51200071
	Höhe: 10-400mm			Messer: 41200001

- 1) Einstellung auf die gewünschte Steinhöhe erfolgt bequem und schnell mit einer Hand über leichtgängige Handkurbel (Messer sollte Werkstück nur minimal berühren)
- 2) Die Handkurbel um eine halbe Drehung zurückdrehen, dass minimaler Spalt zwischen Messer und Werkstück entsteht
- 3) Durch herunterdrücken des Hebels wird der Stein / die Platte durchtrennt

## 5 Modelle Übersicht

Typ	Trennbreite	Trennhöhe	Eigengewicht	Bestell-Nr.
AL-15-EASY-V	175 mm	50-100 mm	14 Kg	51200066
AL-33-EASY-V	330 mm	10-120 mm	42 Kg	51200059
AL-33/D-EASY-V	330 mm	10-120 mm	42 Kg	51200060
AL-33-V	330 mm	10-120 mm	41 Kg	51200042
AL-33/D-V	330 mm	10-120 mm	41 Kg	51200049
AL-33/S-V	50-340 mm	20-140 mm	53 Kg	51200044
AL-43-EASY-V	430 mm	10-120 mm	60 Kg	51200061
AL-43/U-EASY-V	430 mm	10-300 mm	73 Kg	51200064
AL-43/UT-EASY-V	430 mm	10-400 mm	81 Kg	51200068
AL-43-V	430 mm	10-120 mm	57 Kg	51200043
AL-43/S-V	180-430 mm	20-140 mm	63 Kg	51200045
AL-50/KS-V	500 mm	50-120 mm	23 Kg	55300005
AL-50-V Tisch			7 Kg	45300001
AL-65-V	650 mm	10-120 mm	88 Kg	51200047
AL-65-EASY-V	650 mm	10-120 mm	92 Kg	51200067
AL-65/U-EASY-V	650 mm	10-400 mm	104 Kg	51200069
AL-65/UT-EASY-V	650 mm	10-400 mm	115 Kg	51200070
AL-65/KS-EASY-V	650 mm	10-400 mm	105 Kg	51200071

## 5.1 Bedienung

### 5.1.1 Steine mittig Spalten

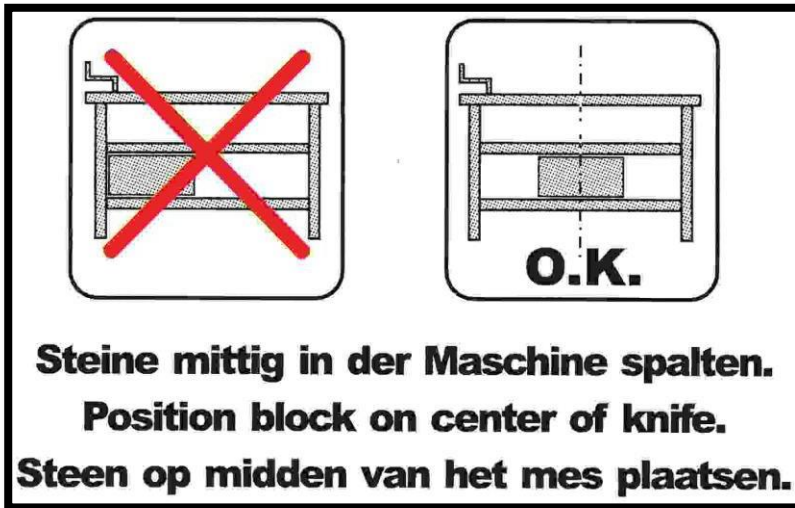

### 5.1.2 Gerätebedienung

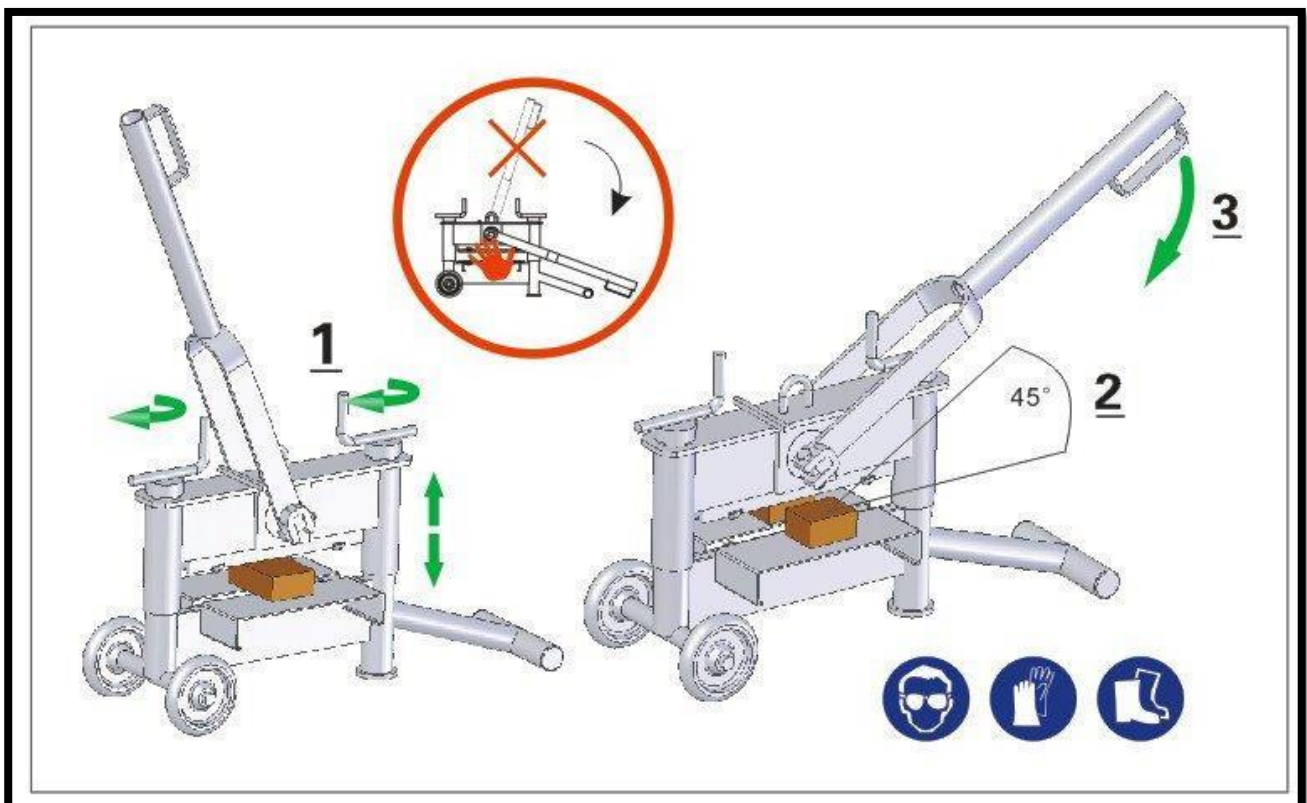

1. Das Gerät in die richtige Höhe bringen (Messerabstand zum Schneidgut 0-5mm)
2. Winkel und Auflagefläche beachten
3. Hebel ziehen um das Schneidgut zu Spalten

## 6 Wartung und Pflege

### 6.1 Wartung



Um eine einwandfreie Funktion, Betriebssicherheit und Lebensdauer des Gerätes zu gewährleisten, sind die in der unteren Tabelle aufgeführten Wartungsarbeiten nach Ablauf der angegebenen Fristen durchzuführen.

Es dürfen **nur Original-Ersatzteile** verwendet werden, ansonsten erlischt die Gewährleistung.



Alle Arbeiten dürfen nur bei stillgelegtem Gerät erfolgen!

Bei allen Arbeiten muss sichergestellt sein, dass sich das Gerät nicht unabsichtlich schließen kann.

**Verletzungsgefahr!**

WARTUNGSFRIST	Auszuführende Arbeiten
Täglich	<ul style="list-style-type: none"> <li>Maschine von Steinstaub reinigen</li> </ul>
Monatlich	<p>Schnittzähne des Unter- und Obermessers auf Verschleiß prüfen Messer bei Bedarf drehen oder ersetzen. Ein Messer hat drei Schnittkanten und kann daher drei Mal verwendet werden. Siehe auch Explosionszeichnung in der Anlage.</p> <p>Tätigkeiten:</p> <ul style="list-style-type: none"> <li>Befestigungsschraube lösen</li> <li>Messer um 90° (oder 120°) drehen oder austauschen</li> <li>Befestigungsschraube anziehen</li> </ul>
Monatlich	<ul style="list-style-type: none"> <li>Maschine auf Verschleiß und Schäden prüfen</li> </ul>

### 6.2 Reparaturen



- Reparaturen am Gerät dürfen nur von Personen durchgeführt werden, die die dafür notwendigen Kenntnisse und Fähigkeiten besitzen.
- Vor der Wiederinbetriebnahme muss eine außerordentliche Prüfung durch einen Sachverständigen durchgeführt werden.

### 6.3 Prüfungspflicht

- Der Unternehmer hat dafür zu sorgen, dass das Gerät mindestens jährlich durch einen Sachkundigen geprüft und festgestellte Mängel sofort beseitigt werden (→ siehe DGUV Vorschrift 1-54 und DGUV Regel 100-500).
- Die dementsprechenden gesetzlichen Bestimmungen u. die der Konformitätserklärung sind zu beachten!
- Die Durchführung der Sachkundigenprüfung kann auch durch den Hersteller Probst GmbH erfolgen. Kontaktieren Sie uns unter: [service@probst-handling.com](mailto:service@probst-handling.com)
- Wir empfehlen, nach durchgeführter Prüfung und Mängelbeseitigung des Gerätes die Prüfplakette „Sachkundigenprüfung / Expert inspection“ gut sichtbar anzubringen (Bestell-Nr.: 2904.0056+Tüv-Aufkleber mit Jahreszahl).













# Operating Instructions

Translation of original operating instructions

**Plate- Stone - Composite Stone - Cutter**

**AL**

**Contents**

- 1 General..... 3**
- 2 Safety ..... 3**
  - 2.1 Safety symbols ..... 3
  - 2.2 Safety marking..... 4
  - 2.3 Accident prevention ..... 4
  - 2.4 Function Control ..... 5
  - 2.5 Definition skilled worker / specialist ..... 5
  - 2.6 Authorized use..... 5
  - 2.7 Technical data ..... 5
- 3 Blade models ..... 6**
- 4 Models ..... 7**
- 5 Models Overview ..... 15**
  - 5.1 Operating ..... 16
    - 5.1.1 Stones middle columns ..... 16
    - 5.1.2 Device handling..... 16
- 6 Maintenance and care ..... 17**
  - 6.1 Maintenance ..... 17
  - 6.2 Repairs ..... 17
  - 6.3 Safety procedures ..... 17
  - 6.4 Hints to the type plate..... 18
  - 6.5 Hints to the renting/leasing of PROBST devices ..... 18

## 1 General



- - The device may only be used for its intended purpose as described in the operating instructions, in compliance with the applicable safety regulations and in compliance with the corresponding statutory provisions and the declaration of conformity.
- - Any other use is considered improper and prohibited!
- - The statutory safety and accident regulations valid at the place of use must also be observed.



Before each use, the user must ensure that:

- the device is suitable for the intended use
- is in proper condition
- the material to be cut is suitable for cutting

In case of doubt, contact the manufacturer before commissioning.

## 2 Safety

### 2.1 Safety symbols



#### **Danger to life!**

Identifies imminent hazard. If you do not avoid the hazard, death or severe injury will result.



#### **Hazardous situation!**

Identifies a potentially hazardous situation. If you do not avoid the situation, injury or damage to property can result.



#### **Prohibition!**

Identifies imminent a prohibition. If you do not avoid the prohibition, death and severe injury, or damage to property will result.



Important informations or useful tips for use.

## 2.2 Safety marking

### PROHIBITION SIGN

Icon	Meaning	Order-No.:	Size:
	Do not store the unit with the bracket upright. There is a risk that the bracket will come loose. Risk of injury.	---	---

### WARNING SIGNS

Icon	Meaning	Order-No.:	Size:
	Risk of crushing your hands.	---	---

### MANDATORY MARKS

Icon	Meaning	Order-No.:	Size:
	Wear hearing and eye protection.	29040547	50 mm

## 2.3 Accident prevention



- The workplace has to be covered for unauthorized persons, especially children.
- Take care in case of thunderstorm!



- The workplace must be sufficiently illuminated.
- Take care with handling wet, dirty and not solidified components.



- The working with the device in case of atmospheric editions under 3° C(37,5° F) is forbidden! Because the goods could be fall down caused by dampness or freezing.

## 2.4 Function Control



- Before every usage of the device check the functions and the working condition.
- Maintenance and lubrication are only permitted when device is shut down!



- Do not use the device, until all faults which can cause safety hazards are removed.
- If there are any cracks, splits or damaged parts on any parts of the device, **immediately** stop using it.



- The operating instructions must be available at the workplace every time.
- Do not remove the type plate of the machine.
- Unrecognisable information signs (such as regulatory or prohibition signs) must be replaced.

## 2.5 Definition skilled worker / specialist

Only skilled workers or specialists are allowed to carry out the installation-, maintenance-, and repair work on this device!

Skilled workers or specialists must have for the following points (if it applies for this device), the necessary professional knowledge.

- for mechanic
- for hydraulics
- for pneumatics
- for electricians

## 2.6 Authorized use



**ATTENTION:** The use of this device is only permitted in proximity to the ground (→ chapter “Safety at work”).



**Unauthorized modifications to the device or the use of any additional devices you may have built yourself endanger life and limb and are therefore strictly forbidden!**



- The device is only designed for the use specified in this documentation.
- Every other use is not authorized and is forbidden!
- All relevant safety regulations, corresponding legal regulations, and additional local health and safety regulations have to be observed.



Prior to every operation the user must ensure that:

- the equipment is suited to the intended operation, the functioning and the working condition of the equipment is examined, and the load is suitable to be handled.

*Any doubts about instructions should be raised with the manufacturer prior to use.*

## 2.7 Technical data

The exact technical data (carrying capacity (WLL), dead weight, etc.) are listed on the type plate/data sheet.

### 3 Blade models

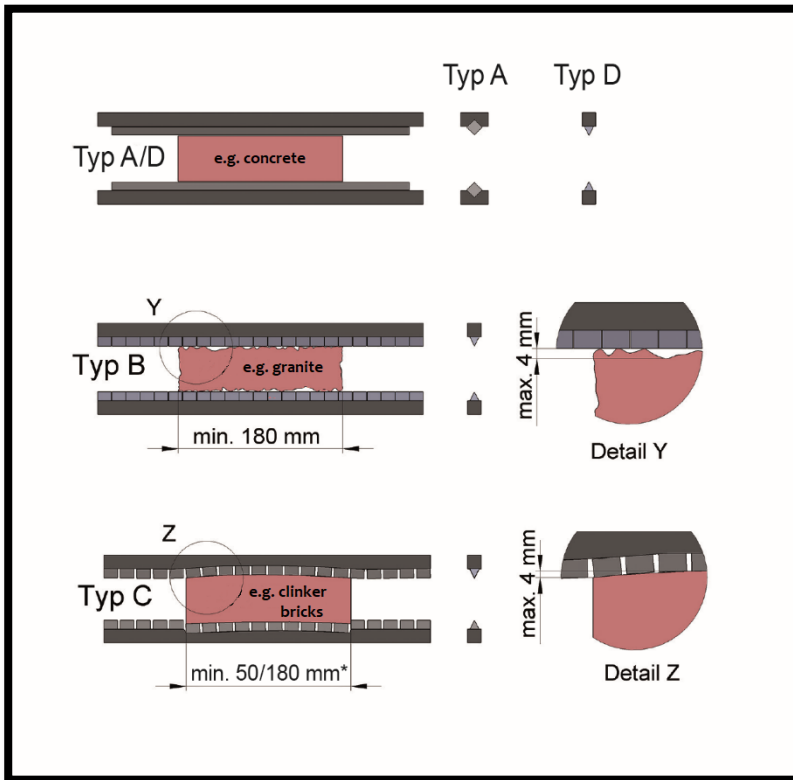

Various stone cutters with optimal cutting blades for every task.

- **Type A+D:** Rigid, continuous triangular / square reversible blade made of hardened tool steel. For everyday tasks, especially for concrete paving stones.
  - Knife type A: 4 cutting edges.
  - Knife type D: 3 cutting edges.
- **Type B:** Rigidly mounted, split triangular reversible blade made of tungsten carbide. E.g. for granite stones, max. 4 mm height difference, minimum stone length.
  - Knife has 3 cutting edges
- **Type C:** Flexibly mounted, split triangular carbide reversible blade. For slightly concave or convex stone elements, such as clinker bricks and large stone slabs with max. 4 mm height difference.
  - \*Minimum stone length 50 mm or 180 mm, depending on model.
  - Knife has 3 cutting edges

4 Models

**AL-15-EASY-V**

Type Blade	Stone size	Application	Weight	Order number
 Blade Type A	Width: 175mm  Height: 50-100mm	Material: concrete  <ul style="list-style-type: none"> <li>• clinker brick</li> <li>• small clinker brick</li> </ul>	14 Kg	51200066

1) Adjustment to the desired brick height is carried out quickly and conveniently with one hand using a smooth-running knurled screw (knives should touch the workpiece only minimally).  
 2) Turn the knurled screw back half a turn so that the minimum gap between the blade and the Workpiece is created  
 3) By pressing down the lever the stone / slab is cut through.

**AL-33-EASY-V**

Type Blade	Stone size	Application	Weight	Order number
 Blade Type A	Width: 330mm  Height: 10-120mm	Material: concrete  <ul style="list-style-type: none"> <li>• paving stones</li> <li>• plates</li> </ul>	42 Kg	51200059  Blade: 41200001

1) Adjustment to the desired brick height is carried out quickly and conveniently with one hand using a smooth-running knurled screw (knives should touch the workpiece only minimally).  
 2) Turn the knurled screw back half a turn so that the minimum gap between the blade and the Workpiece is created  
 3) By pressing down the lever the stone / slab is cut through.

AL-33/D-EASY-V				
Type Blade	Stone size	Application	Weight	Order number
<p>Blade Typ A</p>	Width: 330mm  Height: 10-120mm	Material: concrete  <ul style="list-style-type: none"> <li>• paving stones</li> <li>• plates</li> </ul>	42 Kg	51200060  Blade: 41200001
1) Adjustment to the desired brick height is carried out quickly and conveniently with one hand using a smooth-running knurled screw (knives should touch the workpiece only minimally). 2) Turn the knurled screw back half a turn so that the minimum gap between the blade and the Workpiece is created 3) By pressing down the lever the stone / slab is cut through.				

AL-33-V				
Type Blade	Stone size	Application	Weight	Order number
<p>Blade Typ A</p>	Width: 330mm  Height: 10-120mm	Material: concrete  <ul style="list-style-type: none"> <li>• paving stones</li> <li>• plates</li> </ul>	41 Kg	51200042  Blade: 41200001
1) Adjustment to the desired brick height is carried out quickly and conveniently with one hand using a smooth-running knurled screw (knives should touch the workpiece only minimally). 2) Turn the knurled screw back half a turn so that the minimum gap between the blade and the Workpiece is created 3) By pressing down the lever the stone / slab is cut through.				





AL-33/D-V				
Type Blade	Stone size	Application	Weight	Order number
 Blade Typ A	Width: 330mm  Height: 10-120mm	Material: concrete  <ul style="list-style-type: none"> <li>• paving stones</li> <li>• plates</li> </ul>	41 Kg	51200049  Blade: 41200001
1) Adjustment to the desired brick height is carried out quickly and conveniently with one hand using a smooth-running knurled screw (knives should touch the workpiece only minimally). 2) Turn the knurled screw back half a turn so that the minimum gap between the blade and the Workpiece is created 3) By pressing down the lever the stone / slab is cut through.				

AL-33/S-V				
Type Blade	Stone size	Application	Weight	Order number
 Blade Typ C	Width: 50-340mm  Height: 20-140mm	Material: concrete  <ul style="list-style-type: none"> <li>• paving stones</li> <li>• hardback clinker</li> <li>• - plates</li> </ul>	53 Kg	51200044  Blade: 21100054
1) Adjustment to the desired brick height is carried out quickly and conveniently with one hand using a smooth-running knurled screw (knives should touch the workpiece only minimally). 2) Turn the knurled screw back half a turn so that the minimum gap between the blade and the Workpiece is created 3) By pressing down the lever the stone / slab is cut through.				

AL-43-EASY-V				
Type Blade	Stone size	Application	Weight	Order number
 Blade Typ A	Width: 430mm  Height: 10-120mm	Material: concrete  <ul style="list-style-type: none"> <li>• paving stones</li> <li>• plates</li> </ul>	60 Kg	51200061  Blade: 41200002
1) Adjustment to the desired brick height is carried out quickly and conveniently with one hand using a smooth-running knurled screw (knives should touch the workpiece only minimally). 2) Turn the knurled screw back half a turn so that the minimum gap between the blade and the Workpiece is created 3) By pressing down the lever the stone / slab is cut through.				

AL-43/U-EASY-V				
Type Blade	Stone size	Application	Weight	Order number
 Blade Typ A	Width: 430mm  Height: 10-120mm	Material: concrete  <ul style="list-style-type: none"> <li>• paving stones</li> <li>• plates</li> </ul>	73 Kg	51200064  Blade: 41200002
1) Adjustment to the desired brick height is carried out quickly and conveniently with one hand using a smooth-running knurled screw (knives should touch the workpiece only minimally). 2) Turn the knurled screw back half a turn so that the minimum gap between the blade and the Workpiece is created 3) By pressing down the lever the stone / slab is cut through.				

AL-43/UT-EASY-V				
Type Blade	Stone size	Application	Weight	Order number
 Blade Typ A	Width: 430mm  Height: 10-400mm	Material: concrete  <ul style="list-style-type: none"> <li>• paving stones</li> <li>• plates</li> <li>• sand-lime bricks</li> </ul>	81 Kg	51200068  Blade: 41200002
1) Adjustment to the desired brick height is carried out quickly and conveniently with one hand using a smooth-running knurled screw (knives should touch the workpiece only minimally). 2) Turn the knurled screw back half a turn so that the minimum gap between the blade and the Workpiece is created 3) By pressing down the lever the stone / slab is cut through.				

AL-43-V				
Type Blade	Stone size	Application	Weight	Order number
 Blade Typ A	Width: 430mm  Height: 10-120mm	Material: concrete  <ul style="list-style-type: none"> <li>• paving stones</li> <li>• plates</li> </ul>	57 Kg	51200043  Blade: 41200002
1) Adjustment to the desired brick height is carried out quickly and conveniently with one hand using a smooth-running knurled screw (knives should touch the workpiece only minimally). 2) Turn the knurled screw back half a turn so that the minimum gap between the blade and the Workpiece is created 3) By pressing down the lever the stone / slab is cut through.				

AL-43/S-V				
Type Blade	Stone size	Application	Weight	Order number
<p>Blade Typ C</p>	Width: 180-430mm  Height: 20-140mm	Material: concrete  <ul style="list-style-type: none"> <li>• Paving stones</li> <li>• Plates</li> <li>• -Hard baked clinkers</li> </ul>	63 Kg	51200045  Blade: 21100057
1) Adjustment to the desired brick height is carried out quickly and conveniently with one hand using a smooth-running knurled screw (knives should touch the workpiece only minimally). 2) Turn the knurled screw back half a turn so that the minimum gap between the blade and the Workpiece is created 3) By pressing down the lever the stone / slab is cut through.				

AL-50/KS-V				
Typ Messer	Steingröße	Anwendung	Gewicht	Bestellnummer
<p>Blade Typ A</p>	Width: 500mm  Height: 50-120mm	Material : Sandstone  <ul style="list-style-type: none"> <li>• Sand-lime brick</li> </ul>	23 Kg	55300005  Blade: 41200027
4) Adjustment to the desired brick height is carried out quickly and conveniently with one hand using a smooth-running knurled screw (knives should touch the workpiece only minimally). 5) Turn the knurled screw back half a turn so that the minimum gap between the blade and the Workpiece is created 6) By pressing down the lever the stone / slab is cut through.				

**AL-65-V**

Type Blade	Stone size	Application	Weight	Order number
 Blade Typ A	Width: 650mm  Height: 10-120mm	Material: concrete  <ul style="list-style-type: none"> <li>• paving stones</li> <li>• plates</li> </ul>	88 Kg	51200047  Blade: 41200001
1) Adjustment to the desired brick height is carried out quickly and conveniently with one hand using a smooth-running knurled screw (knives should touch the workpiece only minimally). 2) Turn the knurled screw back half a turn so that the minimum gap between the blade and the Workpiece is created 3) By pressing down the lever the stone / slab is cut through.				

**AL-65-EASY-V**



Type Blade	Stone size	Application	Weight	Order number
 Messer Typ A	Width: 650mm  Height: 10-120mm	Material: concrete  <ul style="list-style-type: none"> <li>• paving stones</li> <li>• plates</li> </ul>	92 Kg	51200067  Blade: 41200001
4) Adjustment to the desired brick height is carried out quickly and conveniently with one hand using a smooth-running knurled screw (knives should touch the workpiece only minimally). 5) Turn the knurled screw back half a turn so that the minimum gap between the blade and the Workpiece is created 6) By pressing down the lever the stone / slab is cut through.				

**AL-65/U-EASY-V**

Type Blade	Stone size	Application	Weight	Order number
 Blade Typ A	Width: 650mm  Height: 10-400mm	Material: concrete  <ul style="list-style-type: none"> <li>• Paving stones</li> <li>• Plates</li> <li>• Curb stones</li> </ul>	104 Kg	51200069  Blade: 41200001
1) Adjustment to the desired brick height is carried out quickly and conveniently with one hand using a smooth-running knurled screw (knives should touch the workpiece only minimally). 2) Turn the knurled screw back half a turn so that the minimum gap between the blade and the Workpiece is created 3) By pressing down the lever the stone / slab is cut through.				

**AL-65/UT-EASY-V**

Type Blade	Stone size	Application	Weight	Order number
 Blade Typ A	Width: 650mm  Height: 10-400mm	Material: concrete  <ul style="list-style-type: none"> <li>• Paving stones</li> <li>• Plates</li> <li>• sand-lime bricks</li> <li>• - Curb stones</li> </ul>	115 Kg	51200070  Blade: 41200001
4) Adjustment to the desired brick height is carried out quickly and conveniently with one hand using a smooth-running knurled screw (knives should touch the workpiece only minimally). 5) Turn the knurled screw back half a turn so that the minimum gap between the blade and the Workpiece is created 6) By pressing down the lever the stone / slab is cut through.				

AL-65/KS-EASY-V				
				
Type Blade	Stone size	Application	Weight	Order number
 Blade Typ A	Width: 650mm  Height: 10-400mm	Material: concrete  <ul style="list-style-type: none"> <li>• Paving stones</li> <li>• Plates</li> <li>• Sand-lime bricks</li> <li>• Curb stones</li> </ul>	105 Kg	51200071  Messer: 41200001
1) Adjustment to the desired brick height is carried out quickly and conveniently with one hand using a smooth-running knurled screw (knives should touch the workpiece only minimally). 2) Turn the knurled screw back half a turn so that the minimum gap between the blade and the Workpiece is created 3) By pressing down the lever the stone / slab is cut through.				

## 5 Models Overview

Typ	Separation width	Separation height	Dead weight	Order-No.
AL-15-EASY-V	175 mm	50-100 mm	14 Kg	51200066
AL-33-EASY-V	330 mm	10-120 mm	42 Kg	51200059
AL-33/D-EASY-V	330 mm	10-120 mm	42 Kg	51200060
AL-33-V	330 mm	10-120 mm	41 Kg	51200042
AL-33/D-V	330 mm	10-120 mm	41 Kg	51200049
AL-33/S-V	50-340 mm	20-140 mm	53 Kg	51200044
AL-43-EASY-V	430 mm	10-120 mm	60 Kg	51200061
AL-43/U-EASY-V	430 mm	10-300 mm	73 Kg	51200064
AL-43/UT-EASY-V	430 mm	10-400 mm	81 Kg	51200068
AL-43-V	430 mm	10-120 mm	57 Kg	51200043
AL-43/S-V	180-430 mm	20-140 mm	63 Kg	51200045
AL-50/KS-V	500 mm	50-120 mm	23 Kg	55300005
AL-50-V Table			7 Kg	45300001
AL-65-V	650 mm	10-120 mm	88 Kg	51200047
AL-65-EASY-V	650 mm	10-120 mm	92 Kg	51200067
AL-65/U-EASY-V	650 mm	10-400 mm	104 Kg	51200069
AL-65/UT-EASY-V	650 mm	10-400 mm	115 Kg	51200070
AL-65/KS-EASY-V	650 mm	10-400 mm	105 Kg	51200071

## 5.1 Operating

### 5.1.1 Stones middle columns

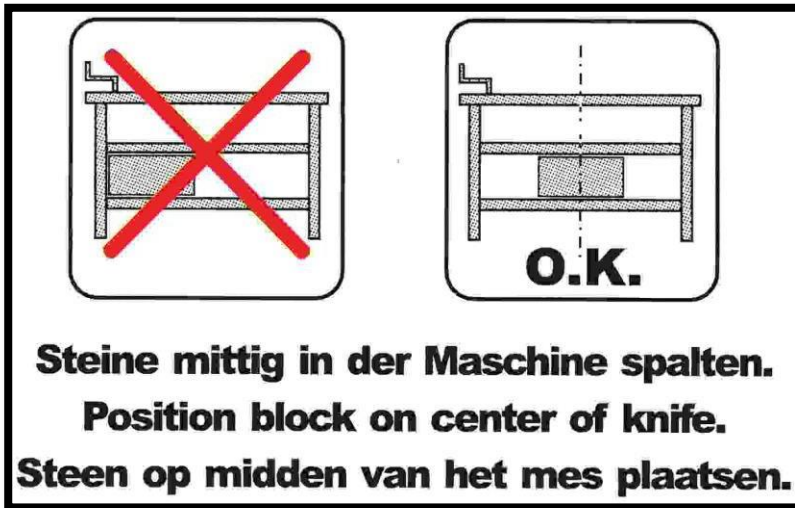

### 5.1.2 Device handling

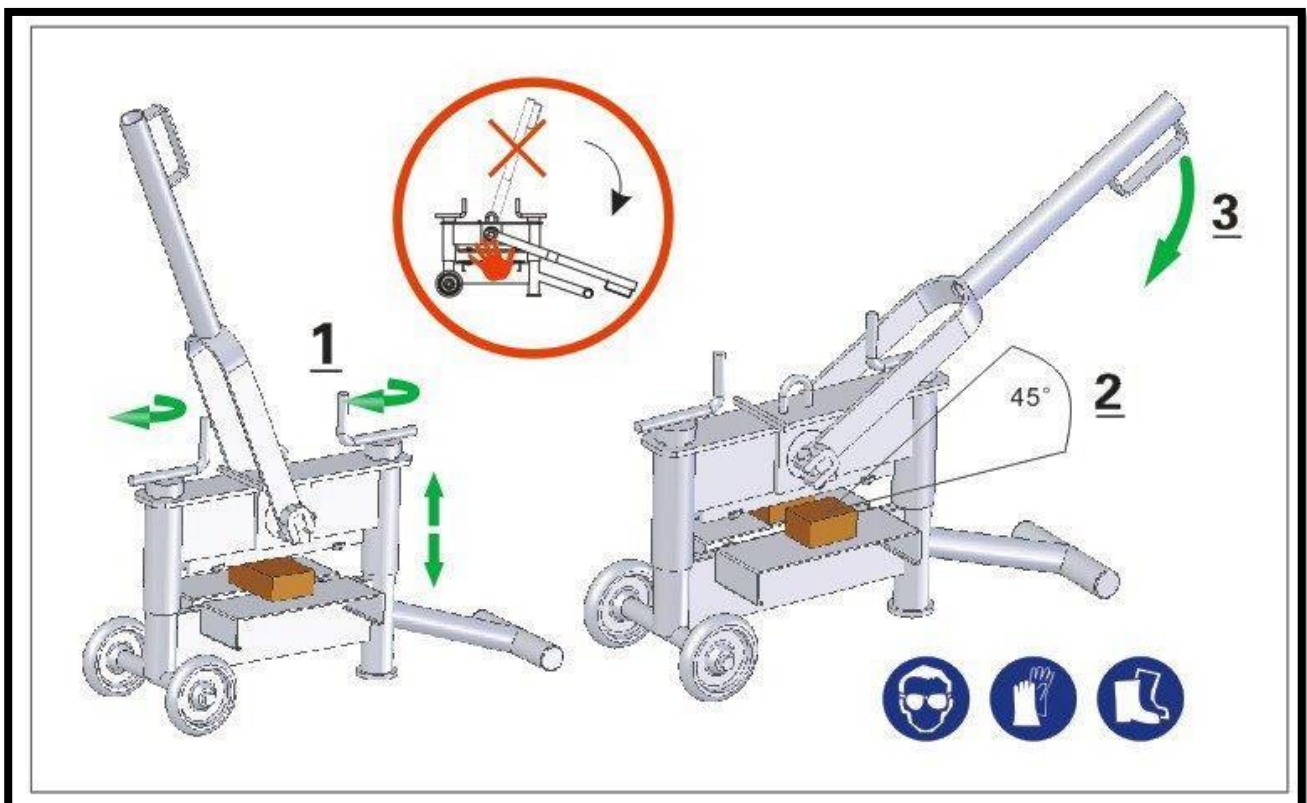

1. Bring the unit to the correct height (distance between knife and material to be cut 0-5mm)
2. Note angle and contact surface
3. Pull the lever to split the material to be cut



## 6 Maintenance and care

### 6.1 Maintenance



To ensure the correct function, safety and service life of the device the following points must be executed in the maintenance interval.

Used **only original spare parts**, otherwise the warranty expires.



All operations may only be made in closed state of the device!  
For all operations you have to make sure, that the device will not close unintended. **Danger of injury!**

MAINTENANCE TIME	Work to be carried out
Daily	<ul style="list-style-type: none"> <li>Clean the machine of stone dust</li> </ul>
Monthly	<p>Check the cutting teeth of the lower and upper knife for wear Turn or replace the knife if necessary. A knife has three cutting edges and can therefore be used three times. See also the exploded view in the appendix.</p> <p>Activities:</p> <ul style="list-style-type: none"> <li>- Loosen the fixing screw.</li> <li>- Turn or replace the blade by 90° (or 120°).               <ul style="list-style-type: none"> <li>- Tighten the fixing screw.</li> </ul> </li> </ul>
Mona Monthly tlich	<ul style="list-style-type: none"> <li>Check machine for wear and damage</li> </ul>

### 6.2 Repairs



Only persons with the appropriate knowledge and ability are allowed to repair the device.  
Before the device is used again, it has to be checked by an expert.

### 6.3 Safety procedures

- It is the contractor's responsibility to ensure that the device is checked by an expert in periods of max. 1 year and all recognized errors are removed (→ see DGUV regulation 1-54 and DGUV norm 100-500).
- The corresponding legal regulations and the regulations of the declaration of conformity must be observed!
- The expert inspection can also be done by the manufacturer Probst GmbH.  
Contact us at: [service@probst-handling.com](mailto:service@probst-handling.com)
- We recommend affixing the inspection sticker "„Sachkundigenprüfung / Expert inspection" in a clearly visible place (order no.: 2904.0056+Tüv sticker with year number) after the inspection has been done.











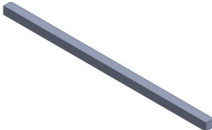









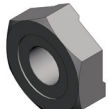



## Platten- und Verbundsteintrenner | Block Cutters AL-33, AL-33/D, AL-43, AL-43/U

Artikel / Article	AL-33	AL-33/D	AL-43	AL-43/U	Best.-Nr. / Order-Number
Ersatzmesser 33 cm Replacement blade 33 cm		2	2		4120.0001
Ersatzmesser 43 cm Replacement blade 43 cm			2	2	4120.0002
Linsenschraube M 8 für Messerhalter Oval-head screw M 8 for blade holder		8	8	8	2007.0007
Ersatzrad Rnd 125 mm 33/33-D Spare wheel around 125 mm		2	2		2182.0001
Ersatzrad Rnd 160 mm Spare wheel around 160 mm			2	2	2182.0003
Auflageblech 33/33-D Support plate		2	2		2110.0033
Auflageblech 43/U, SH-14 / 21 Support plate				1	4120.0025
Feder für Auflageblech Spring for support plate		4	4	2	4120.0009
Nadellager Needle bearing		1	1	1	2136.0003
Kugellager Ball bearing		2	2	2	2135.0003
Schweißmutter Weld nut		2	2	2	4120.0029

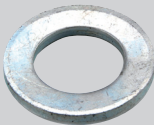

## Platten- und Verbundsteintrenner | Block Cutters AL-33, AL-33/D, AL-43, AL-43/U

Artikel / Article		AL-33	AL-33/D	AL-43	AL-43/U	Best.-Nr. / Order-Number
Mutter Nut		2	2	2	2	4120.0030
Spindel Spindle		2	2	2		4120.0031
Spindel Spindle					2	4120.0032
Ring		2	2	2	2	4120.0033
Hebel Lever		2	2	2	2	4120.0037





## Platten- und Verbundsteintrenner | Block Cutters AL-43/UT, AL-65, AL-65/U, AL-65/UT

Artikel / Article	AL-43/UT	AL-65	AL-65/U	AL-65/UT	Best.-Nr. / Order-Number
Ersatzmesser 33 cm Replacement blade 33 cm		4	4	4	4120.0001
Ersatzmesser 43 cm Replacement blade 43 cm	2				4120.0002
Linsenschraube M 8 für Messerhalter Oval-head screw M 8 for blade holder	8	16	16	16	2007.0007
Ersatzrad Rnd 160 mm Spare wheel around 160 mm	2	2	2	2	2182.0003
Feder für Auflageblech Spring for support plate		4	4		4120.0009
Nadellager Needle bearing	1	1	1	1	2136.0003
Kugellager Ball bearing	2	2	2	2	2135.0003
Schweißmutter Weld nut	2	2	2	2	4120.0029
Mutter Nut	2				4120.0030
Spindel Spindle	2				4120.0032







## Platten- und Verbundsteintrenner | Block Cutters AL-43/UT, AL-65, AL-65/U, AL-65/UT

Artikel / Article	AL-43/UT	AL-65	AL-65/U	AL-65/UT	Best.-Nr. / Order-Number
Ring 	2				4120.0033
Hebel Lever 	2				4120.0037

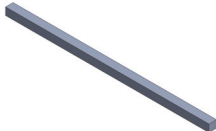

## Platten- und Verbundsteintrenner | Block Cutters AL-65/KS, AL-33/S, AL-43/S, AL-43/SH-14

Artikel / Article	AL-65/KS	AL-33/S	AL-43/S	AL-43/SH-14	Best.-Nr. / Order-Number
Ersatzmesser 33 cm Replacement blade 33 cm 	4				4120.0001
Linsenschraube M 8 für Messerhalter Oval-head screw M 8 for blade holder 	16	30	38	38	2007.0007
Ersatzrad Rnd 125 mm SH-14/21 Spare wheel around 125 mm 				2	2182.0021
Ersatzrad Rnd 160 mm Spare wheel around 160 mm 	2	2	2		2182.0003
Ersatzrad Rnd 200 mm Spare wheel around 200 mm 				2	2182.0020



## Platten- und Verbundsteintrenner | Block Cutters AL-65/KS, AL-33/S, AL-43/S, AL-43/SH-14

Artikel / Article	AL-65/KS	AL-33/S	AL-43/S	AL-43/SH-14	Best.-Nr. / Order-Number
Auflageblech 43/U, SH-14 / 21 Support plate 43/U, SH-14 / 21				2	4120.0025
					
Auflageblech 33/S, 43/S Support plate 33/S, 43/S		2	2		4120.0062
Feder für Auflageblech Spring for support plate		4	4	4	4120.0009
					
Nadellager Needle bearing		1			2136.0003
					
Kugellager Ball bearing		2			2135.0003
					
Schweißmutter Weld nut	2	2	2		4120.0029
					
Mutter Nut		2	2		4120.0034
					
Spindel Spindle		2	2		4120.0035
					
Spindel Spindle				2	4120.0038
					
Ring		2	2		4120.0036
					
Ring				2	4120.0039





## Platten- und Verbundsteintrenner | Block Cutters AL-65/KS, AL-33/S, AL-43/S, AL-43/SH-14

Artikel / Article	AL-65/KS	AL-33/S	AL-43/S	AL-43/SH-14	Best.-Nr. / Order-Number
Hebel Lever 		2	2		4120.0037
Messer für Messerhalter Blade for blade holder 		30	38	38	4120.0005
Messerhalter mit Messer/Bolzen 33/S Blade holder with blade/bolt 33/S 		2			2110.0054
Messerhalter mit Messer/Bolzen 43/S Blade holder with blade/bolt 43/S 			2	2	2110.0057
Kettenrad Chain wheel 				2	4120.0040
Batteriekasten komplett Complete battery box 				1	4120.0041
Stecker (grau) Plug (grey) 				1	4120.0042
Batterie Battery 				1	2420.0121
Batterieladegerät 230 V komplett Complete 230 V battery charger 				1	4120.0043
Batterieladegerät 110 V komplett Complete 110 V battery charger 				1	4120.0044
Kabelschuh für Ladegerät 110 V Cable lug for 110 V charger 				2	2410.0389