



## Fertigteilzange / Grab for Prefabricated Concrete Products FTZ-MULTI-15



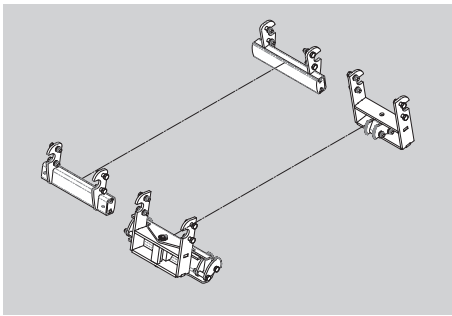

(Grundgerät ohne Greifbacken)

(Basic unit without grippers)

Artikel / Article	Beschreibung / Description	Best.-Nr. / Order-Number
Wechselautomatik Automatic changer 	Einsatz für Wechselautomatik Insert for automatic changer	40110040
Spannstift Spring pin 	für Wechselautomatik, DIN 1481, Dm 8 x 30 for automatic changer, DIN 1481, Dm 8 x 30	20530019
Spannstift Spring pin 	für Wechselautomatik, DIN 1481, Dm 16 x 30 for automatic changer, DIN 1481, Dm 16 x 30	20530038
Federriegel Spring lock 	Federriegel S22 S22 spring lock	20540022
Rollenkette Roller chain 	Einfache Rollenkette Bedarf 2 St. Simple roller chain req. 2 pc.	21000205
Kettenschloss Chain lock 	Kettenschloss mit Splintverschluss Bedarf 4 St. Chain lock with split pin fastening req. 4 pc.	21000226
Handgriff Handle 	Handgriff rot Handle red	21600002

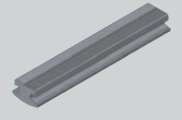

## Greifbacken für / Grippers for FTZ-MULTI-15

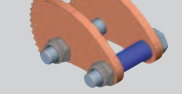
Artikel / Article	Beschreibung / Description	Best.-Nr. / Order-Number
Profil-Gummi-Leiste, schwarz Rubber strip profile, black 	für FTZ-MULTI-15-WB-G-42, PGL2 420 mm lang for FTZ-MULTI-15-WB-G-42, PGL2 420 mm long	36370031
Profil-Gummi-Leiste, grau Rubber strip profile, grey 	für FTZ-MULTI-15-WB-G-42, PGL2 420 mm lang for FTZ-MULTI-15-WB-G-42, PGL2 420 mm long	36370053
Profil-Gummi-Leiste, schwarz Rubber strip profile, black 	für FTZ-MULTI-15-WB-G-120, PGL2 1200 mm lang for FTZ-MULTI-15-WB-G-120, PGL2 1200 mm long	36370018
Profil-Gummi-Leiste, grau Rubber strip profile, grey 	für FTZ-MULTI-15-WB-G-120, PGL2 1200 mm lang for FTZ-MULTI-15-WB-G-120, PGL2 1200 mm long	36370057
Zahnsegment Gear segment 	für FTZ-MULTI-15-WB-SQ, Zahnsegment für Prätze 3 for FTZ-MULTI-15-WB-SQ, Gear segment for claw 3	33500683
Prätze Claw 	für FTZ-MULTI-15-WB-SQ, vormontiert for FTZ-MULTI-15-WB-SQ, preassembled	44000039